

AdvancedMC® Module based on Intel® Xeon® Processor E3-1500 v5 Product Family

Key Features

AM F5x/msd is an AdvancedMC® Single Module (Mid-size or Full-size) based on an Intel® Skylake microarchitecture processor for long life-cycle, high performance applications. Compatible with legacy AMC modules.

- 4-core Intel® Xeon® processor variants for CPU or GPU intensive processing loads
- Gen 3 PCI Express® fabric interface options for flexible connection to other payloads
- Front panel connections including:
 - ➔ 2 x 10GBASE-T Ethernet for networking
 - ➔ DisplayPort™ v1.2, USB 3.0 and Serial interfaces for configuration
- Optional Flash Drive Module for local boot and data storage
- Optional I/O in extended options region

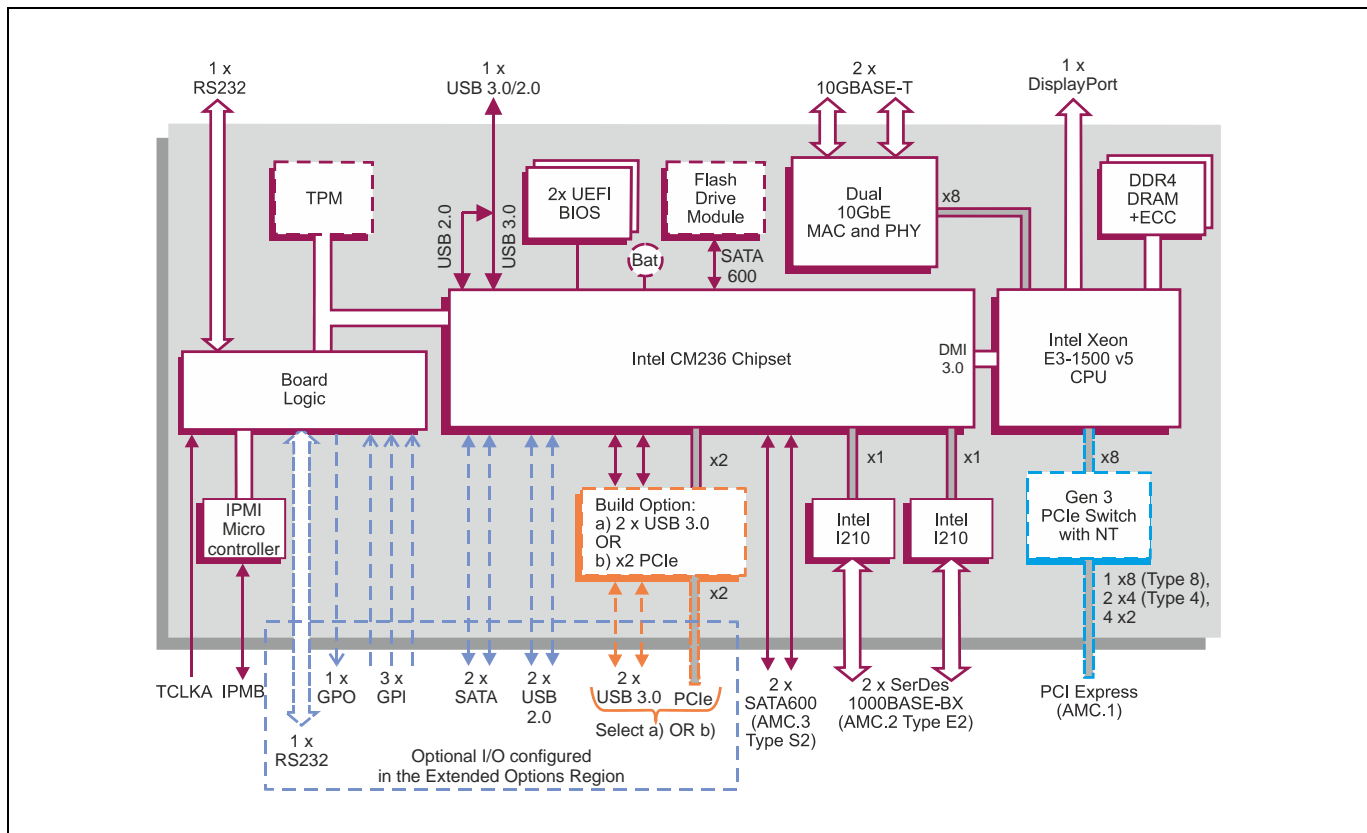
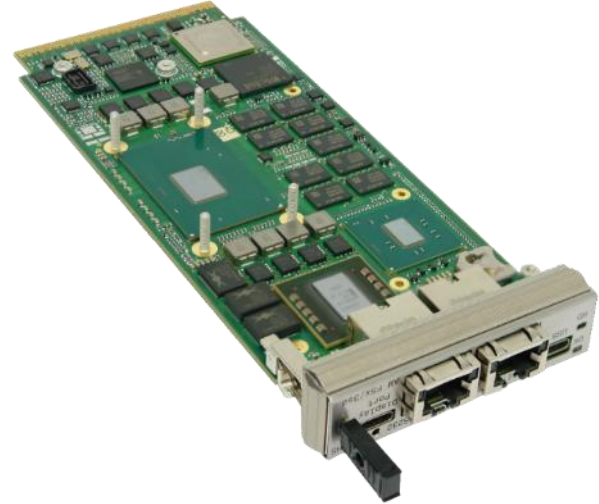

AdvancedMC Computer Board

- AdvancedMC® (AMC) Module utilizing the Intel® Xeon® Processor E3-1500 v5 Product Family
- AMC form factor is a Single Module supporting:
 - Mid-size front panel
 - Full-size front panel
- AMC Fabric Interface supports:
 - PCI Express® (PCIe®)

Central Processor

- Intel Xeon processors supported
- 4-core Intel® Xeon® Processor E3-1515M v5:
 - 8 Mbytes Cache, 2.80 GHz
 - Intel® Iris™ Pro Graphics P580
- 4-core Intel® Xeon® Processor E3-1505M v5:
 - 8 Mbytes Cache, 2.80 GHz
 - Intel® HD Graphics P530
- 4-core Intel® Xeon® Processor E3-1505L v5:
 - 8 Mbytes Cache, 2.00 GHz
 - Intel HD Graphics P530
- utilizes the Intel® CM236 Chipset

DRAM

- 16 Gbytes soldered DDR4 ECC DRAM:
 - single bit error correction
 - dual channel architecture
- accessible from processor and AMC connector

PICMG AdvancedMC Interfaces

- PCIe fabric connection (build option):
 - AMC.1 Type 8 or Type 4 (1 x8 or 2 x4 PCIe port)
 - plus user configurable to 4 x2 PCIe port
 - support for Gen 1, Gen 2 and Gen 3
 - transfer rate up to 8 Gbps
 - supported by a DMA engine in the PCIe switch
 - external or on-board fabric clock support
- hot swap compliant to AMC.0
- rear I/O compliant to AMC specification

Storage Interfaces

- up to 4 x SATA interfaces:
 - AMC.3 Type S2 (2 x SATA600)
 - 2 x SATA in AMC connector extended options region (build option)
- optional SATA600 Flash Drive Module

Ethernet Interfaces

- dual SerDes interfaces via AMC connector:
 - AMC.2 Type E2 (2 x 1000BASE-BX)
 - implemented using two Intel® Ethernet Controller I210-IS devices
- 2 x front panel 10 Gigabit Ethernet interfaces via RJ45 connectors:
 - 10GBASE-T
 - 1000BASE-T
 - 100BASE-TX full-duplex
 - implemented using an Intel® Ethernet Controller X540-AT2 device

Serial Interfaces

- 1 x RS232 interface via front panel Micro USB connector:
 - supports TxD and RxD
- 1 x RS232 interface in AMC connector extended options region (build option):
 - TxD, RxD, RTS and CTS
- 16550 compatible UARTs

Display Interface

- 1 x DisplayPort™ v1.2 interface via front panel Mini DisplayPort connector:
 - up to 3840 x 2160 @ 60 Hz
 - resolution is dependent on the device driver
- support for Microsoft® DirectX 12
- support for OpenGL 4.4 under Windows® and Linux®
- support for OpenCL 2.1

Stereo Audio Interface

- DisplayPort interface supports stereo audio

Other Peripheral Interfaces

- PC-compatible Real Time Clock
- watchdog timer
- 1 x 32-bit Long Duration Timer with processor interrupt capability
- CPU temperature monitor; voltages monitor:
 - all accessible via IPMI
- 1 x GPO and 3 x GPI in AMC connector extended options region (build option)
- up to 5 x USB ports:
 - 1 x USB 2.0/3.0 via front panel (USB Type C connector)
 - 2 x USB 2.0 in AMC connector extended options region (build option)
 - option for 2 x USB 3.0 (replaces x2 PCIe port) in AMC connector extended options region (build option)
 - option for x2 PCIe port (replaces 2 x USB 3.0) in AMC connector extended options region (build option):
 - supports 1 x2 or 2 x1 PCIe ports (up to Gen 2)

Telecom Clock

- TCLKA clock input to board logic:
 - increments 32-bit counter in board logic

Software Support

- supports Linux®, Windows® and VxWorks®
- Fabric Interconnect Networking Software (FIN-S):
 - allows applications on multiple processor boards to efficiently communicate with each other over the fabric
 - optional software, see separate datasheet

Board Security Features

- option for Trusted Platform Module (TPM 2.0)
- option for Sanitization Utility Software Package
- option for proprietary board-level security features

Firmware Support

- UEFI 2.4 boot firmware (BIOS):
 - UEFI 2.4 support
 - includes Compatibility Support Module
 - implements Secure Boot
- optional Fast Boot solution based on the Intel® Firmware Support Package (Intel® FSP)
- LAN boot firmware included

Non-Volatile Memory

- 16 Mbytes of BIOS Flash EEPROM, dual redundant devices

IPMI

- IPMI Version 1.5 according to AMC.0
- on-board BMC (Baseboard Management Controller)
- supports 8 Kbytes of non-volatile memory

Electrical Specification

- typical current consumption for 4-core Intel Xeon E3-1505M v5 processor with 16 Gbytes DRAM:
 - +12V @ 2.5A typical voltage ±2V
- +3.3V @ less than 0.13A, voltage ±5%

Safety

- PCB (PWB) manufactured with flammability rating of UL94V-0

Environmental Specification

- operating temperature:
 - 0°C to +55°C (N-Series)
 - -25°C to +70°C (E-Series, selected processor)
 - all processors for Full-size AMC
 - selected processor for Mid-size AMC
- non-operating temperature: -40°C to +85°C
- 5% to 95% Relative Humidity, non-condensing

Mechanical Specification

- AMC.0 Single Module form-factor 180.6mm x 73.5mm (7.1 inches x 2.9 inches):
 - Full-size panel: 29mm (1.1 inches)
 - Mid-size panel: 19mm (0.75 inches)

Compatible with Legacy Modules

- factory build options enable compatibility with legacy AMC processor modules, e.g.:
 - AM 91x/11x and AM 91x/31x
 - AM 92x/11x and AM 92x/31x
 - AM 95x/11x and AM 95x/31x